

LED Flex-Neon 220V



Potenza

8.5W/m

Colore della luce



Blue

CE

RoHS

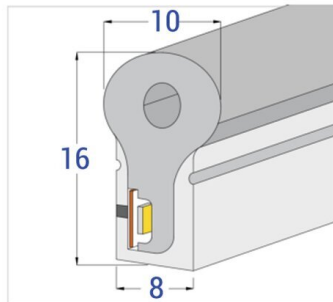

16x10(mm)

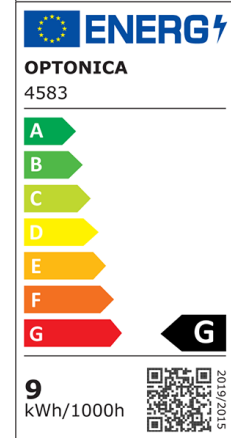
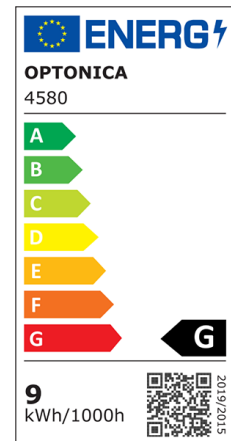
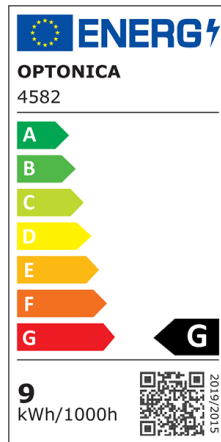
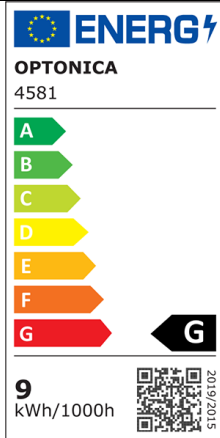

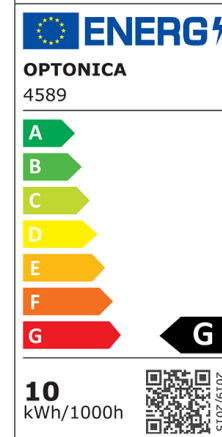
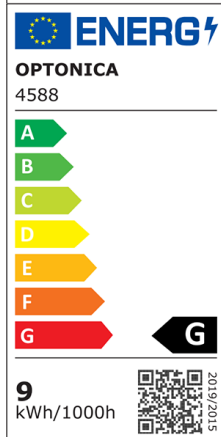
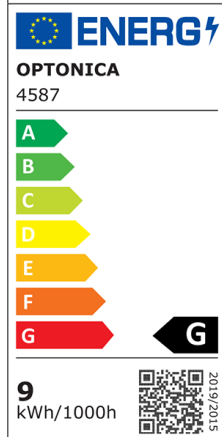
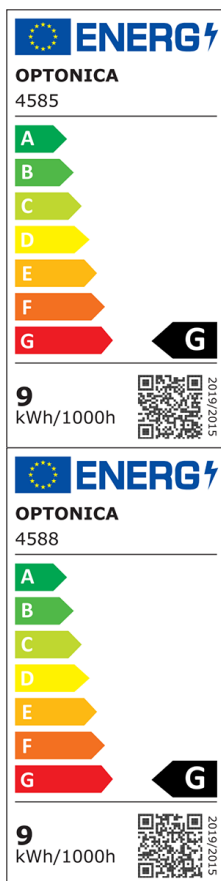
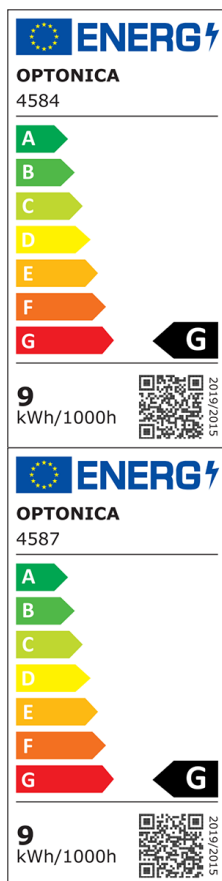

Specifiche tecniche

Numero di catalogo	4583
Angolo del fascio luminoso	120°
Marchio	Optonica
Codice Prodotto	ST220-A2
Designazione del colore	Blue
Dimensione	16x10 mm
Dimmerabile	Yes
EAN Codice	3800156645837
Etichetta di efficienza energetica	G
Input voltage	AC: 220V
Instant On	0.2s
IP	65
Flux	300 lm/m

LEDs/m	120
Tipo di LED	SMD
Durata	25 000 Hours
Flusso luminoso residuo al termine del periodo di funzionamento	70%
Materiale	Flex PCB
Cicli di accensione / spegnimento	25 000x
Frequenza operativa	50-60Hz
Potenza per metro	8.5W/m
Power factor	0.5
Bobina	50 m.
Dimensioni della confezione	330x320x180 mm
Temperatura	-30°C / +50°C
Garanzia	2 Years
Weight of Product	10.750 kg./roll